



Table de pédiatrie fixe

PEDIA05T

CARINA
Medical



CE
ISO 9001
ISO 13485

DESCRIPTION TECHNIQUE

- Table de pédiatrie à hauteur fixe
- Sellerie tendue plate de bonne densité 24kg/cm², non-feu classée M1, épaisseur 5cm, avec rebords densité 34kg/cm² sur 3 côtés
- Equipé d'un porte-rouleau pour drap d'examen, d'un tiroir 600x400
- Piètement acier peint époxy, coloris gris clair (RAL 7035) en standard

DIMENSIONS

- Largeur 100cm
- Profondeur 72cm
- Hauteur 86cm
- Capacité de charge : 80kg

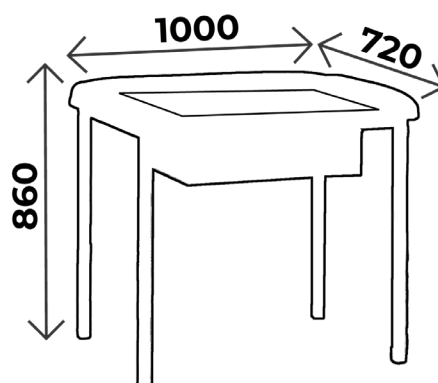

ACCESSOIRE



ACC 990
Jeu de 4 roulettes à frein
diam. 125mm

Vous aimerez aussi :

Réf. **PEDIA04T** : Idem PEDIA05T mais sans tiroir, avec plateau inférieur

Réf. **PEDIA03T** : Idem PEDIA05T mais sans tiroir

Réf. **PEDIA06T** : Idem PEDIA05T mais avec plateau inférieur



À SAVOIR

- ✓ Délai : 15 jours à réception commande
- ✓ Garantie : 2 ans (1 an pour la sellerie)

COLORIS SELLERIE

Sellerie non-feu
classée M1

Pour les coloris de sellerie, vous avez le choix entre la gamme Classique et Urban
Attention ! coloris Classique et Urban **avec plus value**

Revêtement : Sellerie Gamme Classique



Arno



Garonne



Potomac

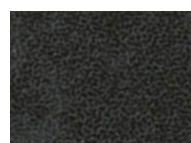

Amour



Mississippi

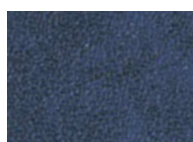

St Laurent



Rhône

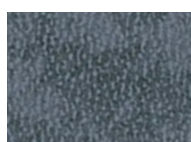

Missouri



Seine

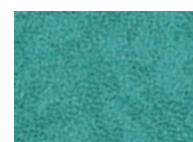

Amazone

Revêtement : Sellerie Gamme Urban



Abysse

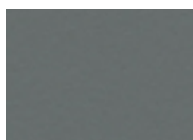

Cendre



Origan

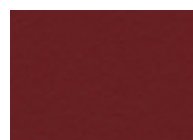

Géranium



Réglisse



Prune

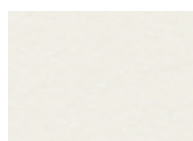

Perle

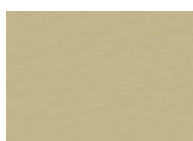

Ficelle

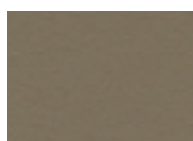

Terre

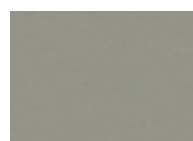

Béton

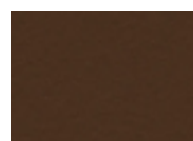

Chataigne

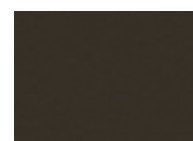

Chocolat



Pensée



Pétrole



Turquoise



Granny



Absinthe



Ananas



Orange



Fuschia



Tomate

COLORIS PIÈTEMENT

La table PEDIA05T a un piètement coloris gris clair (RAL 7035) en standard
Possibilité de changer le coloris **sans plus value**

Piètement Peinture EPOXY

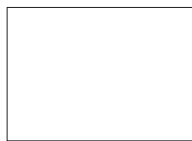

RAL 9003

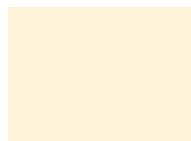

RAL 1013

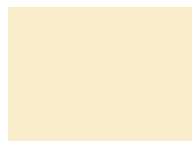

RAL 1015

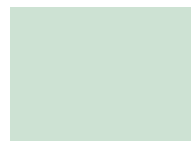

RAL 6019



RAL 6033



RAL 6000



RAL 5017



RAL 5002



RAL 5000

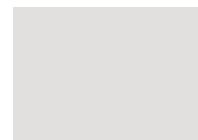

RAL 7035



RAL 7016

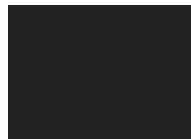

RAL 9005



RAL 1018



RAL 3020



RAL 3003

Attention brillant

ARGENT



GUIDE D'ENTRETIEN

ENTRETIEN QUOTIDIEN

- Sellerie : nettoyage à l'eau savonneuse uniquement (solvants proscrits), peut être désinfecté avec des produits tels que Phagosept Spray, Salvanios pH10 à 0,75% et Anios Surfaces Hautes, sans matière abrasive
- Piètement : nettoyage à l'eau savonneuse uniquement (solvants proscrits) sans matière abrasive

GARANTIE

- Châssis : 2 ans
- Sellerie : 1 an



CONTACT

CARINA
Médical

Parc d'entreprises Visionis
278 rue de l'industrie
01090 GUÉREINS- FRANCE

SERVICE COMMERCIAL

Tél : +33(0)4 74 66 69 49
Fax : +33(0)4 74 66 69 50
commercial@carinamedical.com