



*Photo du modèle avec option double commande*

*Divan de cardiologie*  
**Gamme OVALIA Version 2**  
**OV2-96-125**

**CARINA**  
*Medical*



**CE**  
ISO 9001  
ISO 13485

## DESCRIPTION TECHNIQUE

- Divan de cardiologie à hauteur variable électrique, 2 parties
- Commande : Pédale multifonctions
- Réglage du dossier en toutes positions par vérin électrique
- Position Déclive/Proclive en standard
- Sellerie tendue plate de bonne densité 24kg/cm<sup>2</sup>, non-feu classée M1, épaisseur 5cm
- Châssis composé de 2 colonnes télescopiques pour une grande stabilité du divan
- Equipé d'une partie cardiologie amovible et d'un porte-rouleau pour drap d'examen côté tête
- Piètement carterisé pour une hygiène optimale, coloris gris clair (RAL 7035)
- Sur 4 roulettes diam. 125mm avec freins

## DIMENSIONS

- Largeur 70cm
- Hauteur variable de 48 à 88cm
- Capacité de charge : 200kg en dynamique

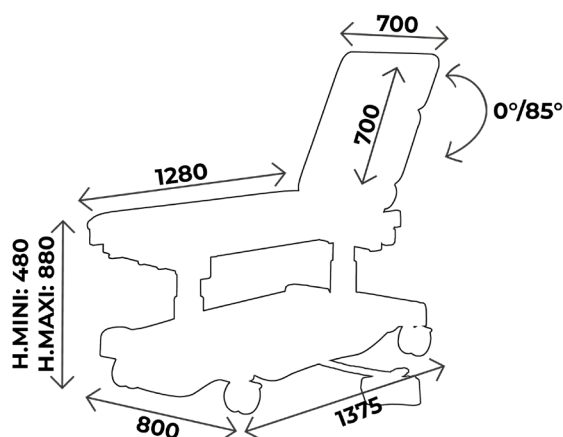

Partie cardiologie amovible pour faciliter les échographies cardiaques et tout autre examen de la cage thoracique

### Vous aimerez aussi :

Réf. **OV2-99-125** : Idem OV2-96-125 mais largeur 80cm

Réf. **OV2-95-125** : Idem OV2-96-125 mais commande par télécommande multifonctions

Réf. **OV2-98-125** : Idem OV2-96-125 mais largeur 80cm et commande par télécommande multifonctions



## À SAVOIR

- ✓ Délai : 15 jours à réception commande
- ✓ Garantie : 5 ans (1 an pour la sellerie)

## ACCESSOIRES



**RL-150**  
4 roulettes diam. 150mm  
Freinage centralisé



**ACC 76-OVALIA-70**  
Jeu d'étaux  
Pour divan largeur 70cm



**ACC 110POLY**  
Gouttière prise de sang  
polyuréthane avec ferrure  
Sans étau, l'unité



**ACC 110**  
Gouttière prise de sang  
Avec ferrure, sans étau, l'unité



**ACC 964**  
Jeu de repose jambes noir,  
sur rotule mousse polyuréthane,  
diam. 14mm, sans étau

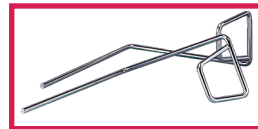

**ACC 105**  
Jeu d'étriers inox standard  
diam. 14mm, sans étau



**SLFEMIREPOSE**  
Housse prélude pour repose  
jambes (ACC964), l'unité



**ACC 514-UNIVERSE**  
Protection plastique transparent  
universelle



**ACC 32012**  
Tige porte-sérum diam. 16mm  
2 crochets plastiques, sans étau



**ACC 76C**  
Etau unitaire  
pour tige porte-sérum  
diam. 16mm



**ACC 832**  
Trou visage avec bouchon

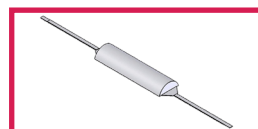

**ACC 54002**  
Tête 1/2 lune largeur 70cm  
Revêtement non feu M1



**ACC OVALIA06**  
Télécommande manuelle OVALIA  
+ Cordon Y (double commande)



**ACC OVALIA05**  
Pédale multifonctions OVALIA  
+ Cordon Y (double commande)



**ACC OVALIA02**  
Paire rails inox 25x10  
long. 1500mm  
Pour OVALIA 2 parties



**ACC BATTERIE01**  
Batterie autonomie de 20 cycles  
(1 cycle = une montée/ descente  
+ une montée/ descente  
de dossier)



**ACC BARRILITOV02**  
Paire de barrières escamotables  
Pour divan largeur 70cm



**ACC TETERGO**  
Tête ergonomique amovible



**ACC-CAPOT**  
Peinture capot  
Autre que le gris standard (7035)  
16 coloris disponibles

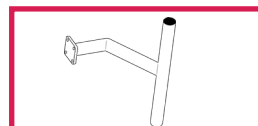

**ACC FEMINA01**  
Support colposcope

# COLORIS SELLERIE

Sellerie non-feu  
classée M1

Pour les coloris de sellerie, vous avez le choix entre la gamme Classique et Urban  
Attention ! coloris Urban **avec plus value**

## *Revêtement : Sellerie Gamme Classique*

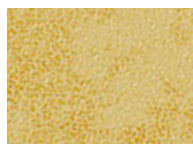

Arno



Garonne



Potomac



Amour

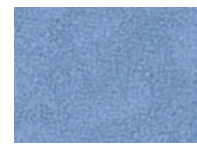

Mississippi

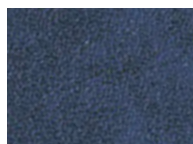

St Laurent



Rhône

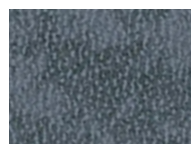

Missouri



Seine

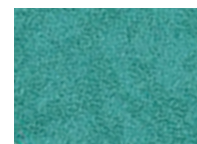

Amazone

## *Revêtement : Sellerie Gamme Urban*



Abysse



Cendre



Origan



Géranium

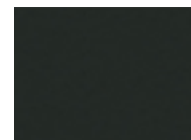

Réglisse



Prune

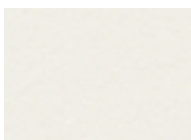

Perle

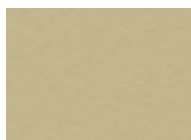

Ficelle

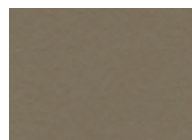

Terre

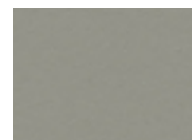

Béton

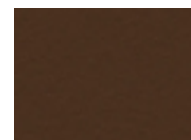

Chataigne

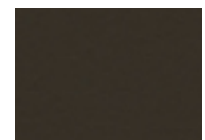

Chocolat

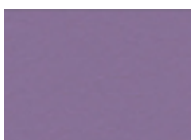

Pensée



Pétrole



Turquoise



Granny



Absinthe



Ananas



Orange



Fuschia



Tomate

# COLORIS PIÈTEMENT

Toute la gamme OVALIA V2 a un capot coloris gris clair (RAL 7035) en standard  
Possibilité de changer le coloris de capot **avec plus value (option ACC CAPOT)**

## *Piètement Peinture EPOXY*



RAL 9003

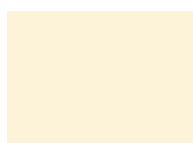

RAL 1013



RAL 1015



RAL 6019



RAL 6033



RAL 6000



RAL 5017



RAL 5002



RAL 5000



RAL 7035



RAL 7016



RAL 9005



RAL 1018



RAL 3020



RAL 3003

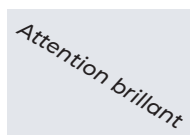

ARGENT



## GUIDE D'ENTRETIEN

### ENTRETIEN QUOTIDIEN

- Sellerie : nettoyage à l'eau savonneuse uniquement (solvants proscrits), peut être désinfecté avec des produits tels que Phagosept Spray, Salvanios pH10 à 0,75% et Anios Surfaces Hautes, sans matière abrasive
- Piètement : nettoyage à l'eau savonneuse uniquement (solvants proscrits) sans matière abrasive

### GARANTIE

- Châssis : 5 ans
- Sellerie : 1 an



**CONTACT**

**CARINA**  
*Médical*

Parc d'entreprises Visionis  
278 rue de l'industrie  
01090 GUÉREINS- FRANCE

**SERVICE COMMERCIAL**

Tél : +33(0)4 74 66 69 49  
Fax : +33(0)4 74 66 69 50  
[commercial@carinamedical.com](mailto:commercial@carinamedical.com)