



Divan d'examen fixe
Gamme ECOMAX
ECOMAX-URGENCE

CARINA
Medical



CE
ISO 9001
ISO 13485

DESCRIPTION TECHNIQUE

- Divan brancard, 2 parties
- Réglage de la tête par 2 crémaillères indexables
- Sellerie tendue plate de bonne densité 24kg/cm², non-feu classée M2, épaisseur 6cm
- Equipé de poignées de poussée et d'une paire de barrières escamotables
- Piètement acier peint époxy, coloris argent
- Sur 4 roulettes diam. 125mm freinage indépendant

DIMENSIONS

- Largeur 60cm
- Hauteur 84cm
- Capacité de charge : 150kg

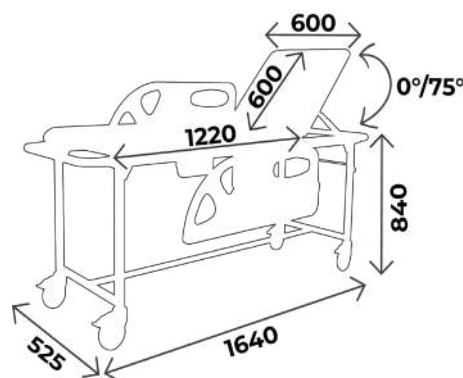

Découvrez la gamme ECOMAX



À SAVOIR

- ✓ Délai : 15 jours à réception commande
- ✓ Garantie : 5 ans (1 an pour la sellerie)

COLORIS SELLERIE

Sellerie non-feu
classée M2

Pour les coloris de sellerie, vous avez le choix entre la gamme ECOMAX, Classique et Urban
Attention ! coloris Classique et Urban **avec plus value**

*Revêtement : Sellerie Gamme ECOMAX**



Galapagos



Bahamas

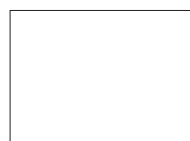

Blanc



Tahiti



Malouines

*Coloris standards pour gamme ECOMAX et SIMPLEX,
coloris Classique et Urban disponibles **sur demande**

COLORIS SELLERIE

Sellerie non-feu
classée M1

Attention ! coloris Classique et Urban avec plus value

Revêtement : Sellerie Gamme Classique



Arno



Garonne



Potomac



Amour



Mississippi



St Laurent

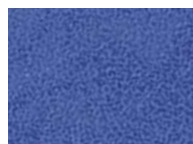

Rhône

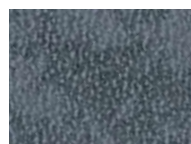

Missouri



Seine



Amazone

Revêtement : Sellerie Gamme Urban



Abysse

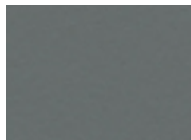

Cendre



Origan

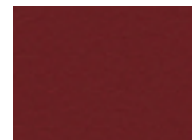

Géranium



Réglisse



Prune

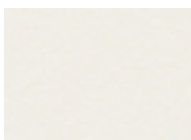

Perle

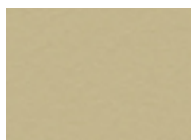

Ficelle

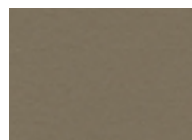

Terre

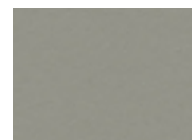

Béton

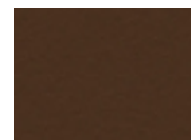

Chataigne

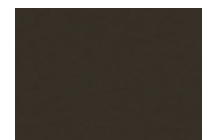

Chocolat

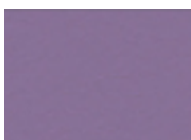

Pensée



Pétrole



Turquoise



Granny



Absinthe



Ananas



Orange



Fuschia



Tomate



GUIDE D'ENTRETIEN

ENTRETIEN QUOTIDIEN

- Sellerie : nettoyage à l'eau savonneuse uniquement (solvants proscrits), peut être désinfecté avec des produits tels que Phagosept Spray, Salvanios pH10 à 0,75% et Anios Surfaces Hautes, sans matière abrasive
- Piètement : nettoyage à l'eau savonneuse uniquement (solvants proscrits) sans matière abrasive

GARANTIE

- Châssis : 5 ans
- Sellerie : 1 an



CONTACT

CARINA
Médical

Parc d'entreprises Visionis
278 rue de l'industrie
01090 GUÉREINS- FRANCE

SERVICE COMMERCIAL

Tél: +33(0)4 74 66 69 49
Fax: +33(0)4 74 66 69 50
commercial@carinamedical.com